

Universal and powerful battery system for a variety of applications

Colibri II

Instructions for Use



Table of Contents

Introduction	General Information	3
---------------------	---------------------	---

Colibri II	Handpiece	7
	Use	9

Attachments	General Information	14
	Drill Attachments	16
	Screw Attachments	17
	Ream Attachments	18
	Other Rotating Attachments	20
	Saw Attachments	25
	Other Attachments	29

Care and Maintenance	General Information	30
	Cleaning and Disinfection	31
	• Preparation Prior to Reprocessing	31
	• Manual Cleaning Instructions	32
	• Automated Cleaning Instructions with Manual Pre-cleaning	36
	Maintenance and Lubrication	39
	Function Control	43
	Packaging, Sterilization and Storage	44
	Repairs and Technical Service	46
	Disposal	47

Troubleshooting	48
------------------------	----

System Specifications	50
<hr/>	
Electromagnetic Compatibility	56
<hr/>	
Additional Information	60
<hr/>	
Ordering Information	61

Introduction

General Information

Intended use

The Colibri II is designed for the use in traumatology and orthopedic surgery of the skeleton, i.e. drilling, reaming or cutting bone.

Safety instructions

The surgeon has to evaluate if the machine is suitable for an application, based on power limitation of the machine, attachment and cutting tool regarding bone strength/anatomical situation as well as handling of the machine, attachment and cutting tool regarding bone size. In addition, the contraindications of the implant have to be respected. Please refer to the corresponding "Surgical Techniques" of the implant system used.

The Colibri II is only to be used for surgery after careful consultation of the instructions for use. It is recommended that an alternative system is available to use during application, as technical problems can never be completely ruled out.

The Colibri II is designed for use by physicians and trained medical personnel.

DO NOT use any component if damage is apparent.

DO NOT use any component if the packaging is damaged.

DO NOT use this equipment in the presence of oxygen, nitrous oxide or a mixture consisting of flammable anesthetics and air.

To ensure the proper operation of the tool, only use Synthes original accessories.

Before the first and every subsequent use, power tools and their accessories/attachments have to run through the complete reprocessing procedure. Protective covers and foils must be fully removed before sterilization.

For the tool to function properly, Synthes recommends cleaning, disinfecting and servicing it after each use in accordance with the process recommended in the chapter "Care and Maintenance". Compliance with these specifications can considerably extend the service life of the tool. Only use Synthes oil (519.970) to lubricate the tool.

Efficiently working cutting tools are the basis for successful surgery. Therefore, it is mandatory to check used cutting tools after every use for wear and/or damage and to replace them if necessary. We recommend using new Synthes cutting tools for every surgery. Cutting tools must be cooled with irrigation liquid to prevent heat necrosis.

The user of the product is responsible for proper use of the equipment during surgery.

If the Colibri II is used in conjunction with an implant system, make sure to consult the corresponding "Surgical Techniques".

For important information regarding electromagnetic compatibility (EMC), please refer to the chapter "Electromagnetic Compatibility" in this manual.

The tool is classified as type BF against electrical shock and leakage current. The tool is suitable for use on patients in accordance with IEC 60601-1.

This system requires regular maintenance service, at least once a year, in order to maintain its functionality. This service has to be performed by the original manufacturer or an authorized site.

The manufacturer assumes no responsibility for damage resulting from neglected or unauthorized maintenance.

Unusual Transmissible Pathogens: Surgical patients identified as at risk for Creutzfeldt-Jakob disease (CJD) and related infections should be treated with single-use instruments. Dispose of the instruments used or suspected of use on a patient with CJD after surgery and/or follow the current national recommendations.

Precautions:

- To avoid injuries, the locking mechanism of the tool has to be activated before every manipulation and before placing the tool back down, i.e. the mode switch has to be in OFF position.
- The tool must only be operated with a fully charged battery. To do this, ensure that the battery is charged in good time. We recommend that the battery is replaced into the charger immediately after surgery.
- The aseptic transfer is detailed on page 9ff. Alternatively for the Li-Ion battery 532.103 follow the guidelines provided in the STERRAD®/V-PRO® sterilization guide (DSEM/PWT/0591/0081). No other sterilization methods are allowed.
- Additionally, the batteries must never be washed, rinsed or dropped. This will destroy the battery with possible secondary damage (explosion hazard!). Only use original Synthes batteries. Further information can be found on page 12ff.
- Should the machine drop on the floor and have visible defects, do not use it anymore and send it to the Synthes service center.
- If a product drops on the floor, fragments may split off. This represents a danger for the patient and user as:
 - these fragments may be sharp.
 - unsterile fragments may enter the sterile field or hit the patient.
- Should the system have corroded parts, do not use it anymore and send it to the Synthes service center.

Accessories/Scope of delivery

The Colibri II consists of a handpiece, one or several battery casings and batteries and a range of attachments and accessories designed for the system.

For the system to operate properly, only Synthes cutting tools should be used.

Special auxiliaries such as cleaning brushes and Synthes oil are available for cleaning and servicing the system. No oils from other manufacturers must be used. Only Synthes oil (519.970) must be used.

Lubricants with other compositions can cause jamming, can have a toxic effect or can have a negative impact on the sterilization results. Only lubricate the power tool and the attachments when clean.

Synthes recommends the use of the specifically designed Synthes Vario Case (68.001.255) and of the specifically designed Washing Basket (68.001.610) to sterilize and store the system.

The following components are essential to ensure proper operation:

- Handpiece (532.101)
- Battery Casing (532.132)
- Battery (532.103)
- Sterile Cover (532.104)
- Universal Battery Charger II (05.001.204)
- At least one attachment of the system

Please refer to the end of these Instructions for Use for an overview of the components of the system.

Locating of the instrument or fragments of instruments

Synthes instruments are designed and manufactured to perform within the scope of their intended use. However, if a Power Tool or accessory/attachment breaks during use, a visual inspection or a medical imaging device (e.g. CT, Radiation Devices, etc.) can aid in locating the fragments and/or components of the instrument.

Storage and transport

Please use the original packaging for dispatch and transport. If this is no longer available, please contact the Synthes office.

Warranty/Liability

The warranty for the tools and accessories does not cover damage of any kind resulting from improper use, damaged seals or improper storage and transport. The manufacturer excludes liability for damage resulting from repairs or maintenance carried out by unauthorized sites. The manufacturer assumes no responsibility for damage resulting from neglected or unauthorized maintenance.

Explanation of the general symbols used



Caution
Read the provided Instructions for Use before operating the device.



Consult the Instructions for Use before operating the device.



The device is classified as type BF against electrical shock and leakage current. The device is suitable for use on patients according to the standards defined by IEC 60601-1



Do not immerse device in liquids.



Product is UL classified to the requirements of both the United States and Canada



The device meets the requirements of directive 93/42/EEC for medical devices. It is authorized by an independent notified body for which it bears the CE symbol.



This device contains Lithium-Ion batteries that should be disposed of in an environmentally friendly manner. The European Battery Directive 2006/66/EC applies to this device. See section "Disposal" on page 47.



The European directive 2012/19/EC on waste electrical and electronic equipment (WEEE) applies to this device. This device contains materials that should be disposed of in accordance with environment protection requirements. Please observe national and local regulations. See section "Disposal" on page 47.



Indicates Environment Friendly Use Period of 5 years in China.



Indicates Environment Friendly Use Period of 10 years in China.



Do not reuse
Products intended for single use must not be reused.

Reuse or reprocessing (e.g. cleaning and resterilization) may compromise the structural integrity of the device and/or lead to device failure, which may result in patient injury, illness or death.

Furthermore, reuse or reprocessing of single use devices may create a risk of contamination e.g. due to the transmission of infectious material from one patient to another. This could result in the injury or death of the patient or user.

Synthes does not recommend reprocessing contaminated products. Any Synthes product that has been contaminated by blood, tissue and/or bodily fluids/matter should never be used again and should be handled according to hospital protocol.

Even though they may appear undamaged, the products may have small defects and internal stress patterns that may cause material fatigue.



Temperature



Relative humidity



Atmospheric pressure

S9

Duty cycle type according to IEC60034-1

IPX4

Ingress protection rating according to IEC 60529



Manufacturer



Date of manufacture



Non sterile



Non sterile



Do not use if package is damaged.

Colibri II Handpiece

- 1 Attachment coupling
- 2 Trigger for speed regulation
- 3 Trigger for switching to reverse/oscillating drilling
- 4 Mode selector switch OFF (lock), Oscillating Mode (forward/oscillating), ON (forward, reverse)
- 5 Battery pack (battery casing with inserted battery)
- 6 Release buttons for attachment
- 7 Release buttons for battery casing
- 8 Knob for the battery casing cover

Safety system

The Colibri II is equipped with a safety system that prevents the machine from being unintentionally started. To lock and unlock the tool, turn the mode selector switch **4** to the appropriate setting on the front plate of the handpiece: OFF,  or ON position.

Protective systems

The Colibri II is equipped with three protective systems:

- A thermal overload safety system that shuts off the tool if it becomes too hot during use. After cooling, the tool can be used again.
- An exhaustive discharge protection ensures that the battery does not completely discharge. This protects the battery and extends its life.
- An internal fuse in the battery that blows in case of unintended short cut. This prevents excessive heat, fire or explosion. If this happens, the battery can not be used anymore.

Speed and rotational direction control

Mode selector switch in the ON position

The bottom trigger **2** gradually increases and decreases the forward/reverse speed. When the bottom and top triggers **2** and **3** are pressed at the same time, the tool immediately switches to reverse. When the bottom trigger **2** is released, the tool immediately stops.



Mode selector switch in the oscillating drilling position (Ω)

When the bottom and top triggers **2** and **3** are pressed at the same time, the tool immediately switches to oscillating rotation. When the top trigger **3** is released, the tool returns to normal forward rotation.

Compatibility between Colibri and Colibri II

Existing Colibri battery packs are compatible with Colibri II handpiece

The small 12 VDC battery pack of the Colibri (532.003 with battery casing 532.002) as well as the large 14.4 VDC battery pack (532.033 with battery casing 532.032) can both be used with the new Colibri II handpiece (532.101).

Existing Colibri handpiece is compatible with Colibri II battery pack

The existing Colibri handpiece (532.001) can be used with the new battery pack of the Colibri II (532.103 with battery casing 532.132).

For additional information on the 12 VDC battery pack (532.002, 532.003 or 532.004), please refer to section "Additional Information" on page 60 of these Instructions for Use.

Precautions:

- The information contained in this Information for Use concerns the Colibri II system. For more information on the Colibri articles, please refer to the Colibri Instructions for Use (036.000.173).
- To prevent injury, the machine must be locked (OFF position) with the mode selector switch **4** when coupling and removing attachments and tools, and before laying it down (see page 7).
- Always check correct functioning before use on patient.
- Always have a back-up system to prevent problems in case of deficient system.
- Always wear personal protective equipment (PPE) including safety goggles when working with the Colibri II system.
- When the tool is not in use during the surgery, set the handpiece on its side to ensure that it does not fall over due to instability. Only place the power tool in an upright position on the sterile table to insert/remove attachments and cutting tools.
- After inserting a cutting tool, always check that it is properly engaged by pulling it.

Warning: Do not place the Colibri II on a magnetic surface since the machine might start unintentionally.

Colibri II

Use

Before initial use, brand-new tools and accessories must undergo the entire reprocessing process and the batteries should be charged. Completely remove protective caps and films.

Inserting the unsterile battery in the battery casing

The aseptic transfer is detailed below. Alternatively for the Li-Ion battery 532.103 follow the guidelines provided in the STERRAD/V-PRO sterilization guide (DSEM/PWT/0591/0081).

To ensure sterility of the battery casing, the battery is inserted into the battery casing by two people, one of whom is wearing sterile garments:

1. The person with the sterile garments holds the sterile battery casing. If the casing is not opened, the same person presses the central button to unlock (Fig. 1), turns the lid sideways (90°) as indicated by the arrow (Fig. 2) and pulls to open (Fig. 3). Leave the locking mechanism swung outward.
2. The person wearing the sterile garments places the sterile cover on the battery casing (Fig. 4) and checks if it is seated correctly. The sterile cover ensures that the unsterile battery does not contact the outside of the sterile casing.



Figure 1



Figure 2



Figure 3



Figure 4

3. The person not wearing sterile garments carefully guides the unsterile battery through the sterile cover (Fig. 5). As an orientation guide, the two symbols of the battery and the sterile cover should face each other (Fig. 6). The same person presses it completely into the battery casing to ensure a correct seat (Fig. 7). This person may not contact the outside of the battery casing.
4. The person not wearing sterile garments grasps the flanges on the sterile cover and removes it from the battery casing (Fig. 8).
5. The person wearing the sterile garments closes the casing cover from the outside without contacting the battery or the inside of the casing. After having closed the casing cover, turn the lid sideways (90°) until it clicks.



Figure 5



Figure 6



Figure 7



Figure 8

Precautions:

- Normally, one battery is sufficient for one surgery. For safety, two battery packs (battery casing with the battery) should be kept ready to ensure fast intraoperative change of batteries under sterile conditions.
- Do not open a battery casing intraoperatively to insert a new battery. Always replace the whole battery pack by another battery pack which should have been prepared before the start of the surgery.
- Sterile battery casings that were in contact with unsterile batteries during insertion of the batteries must be resterilized before being used in the OR.
- To close the casing cover, press it firmly to ensure that it is completely closed (Fig. 9 and 10) so that the locking mechanism properly engages. Always check that the cover is totally closed before using the system.
- Sterilize the sterile cover after each use to ensure aseptic conditions when inserting the unsterile battery into the sterile battery casing.



Figure 9



Figure 10

Inserting the battery pack into the power tool

Guide the battery pack (battery casing with inserted battery) from below into the shaft of the handpiece (Fig. 11). The shape of the battery casing prevents the battery from being inserted incorrectly. Check if the battery pack is seated correctly by gently pulling on it.

Removing the battery pack from the power tool

Simultaneously press the release buttons for the battery casing with one hand (Fig. 12) and use the other hand to remove the battery pack from the handpiece.



Figure 11



Figure 12

Precautions and warnings concerning testing, measuring, charging, storing and usage of Colibri II batteries (532.103)

Testing and Measuring

- Do not short-circuit the battery. Do not try to measure the short-circuit current. This will blow the internal fuse of the battery with irreversible damage of the battery.
- Never open or disassemble the battery.

Charging

- Only use the Synthes Universal Battery Charger II (05.001.204) to charge the battery. The charger should have a software version of 11.0 or higher. A label placed on the bottom of the charger enables to identify the latest software version of the charger. Never charge the battery in another Synthes charger or a charger from another manufacturer. This will damage the battery.
- The batteries should always be charged before use.
- Place the battery into the charger immediately after surgery.

Storage

- Always recharge the battery after each use. Do not store an empty battery as this will shorten the life span and will not be covered by warranty.
- When the battery is not being used, always store it in the Synthes Universal Battery Charger II and turn the charging station on. This will avoid the battery from discharging, and it will be fully charged and ready to use. Never store the battery in another Synthes charger nor a charger from another manufacturer. This will damage the battery.
- Never store the battery in the battery casing (532.132) when it is connected to the Colibri II handpiece (532.101) as this will discharge the battery.
- When storing batteries, ensure that they are separately packed and do not store them with materials that conduct electricity in order to prevent short-circuit. This could damage the battery and generate heat which can cause burns.

Use

- Only use the battery for its intended use. Do not use any battery which is not designed for the equipment.
- Only insert the battery pack (battery and battery casing) in the handpiece directly before using the Colibri II system. This saves battery energy and prevents having the need to change it during surgery.
- Do not apply force to the battery and do not let it fall. This will destroy it with possible secondary damage.
- Never use a damaged or faulty battery; it can damage the power tool.
- Do not use a faulty or damaged battery, as this may damage the power tool. Test the status of the battery using the Universal Battery Charger II.
- If the drive unit is defect (e.g. short-circuited) do not insert a battery, as this will blow the internal fuse and cause damage to the battery. Send the drive unit and battery to the Synthes Service Center.
- Do not use a faulty or damaged battery, as this may damage the power tool. Test the status of the battery using the Universal Battery Charger II.
- If the drive unit is defect (e.g. short-circuited) do not insert a battery, as this will blow the internal fuse and cause damage to the battery. Send the drive unit and battery to the Synthes Service Center.

Care and Maintenance

- **The batteries must never be washed, rinsed or dropped. This will destroy the batteries with possible secondary damage. Cleaning and Disinfection instructions of the batteries can be found in the chapter "Care and Maintenance".**
- **The aseptic transfer is detailed on page 9ff. Alternatively for the Li-Ion battery 532.103 follow the guidelines provided in the STERRAD/V-PRO sterilization guide (DSEM/PWT/0591/0081). No other sterilization methods are allowed.**

Precautions:

- **Do not expose batteries to heat or fire. Avoid storage in direct sunlight.**
- **Keep the batteries and the Universal Battery Charger II clean and in a cool and dry place.**
- **Risk of fire, explosion and burns. Do not disassemble, crush, heat above 60°C/140°F or incinerate the battery cells.**

Oscillating drilling (Ω) mode

To protect soft tissue when drilling and inserting Kirschner wires, the Colibri II has an electronically controlled oscillating mode.

To preset the oscillating mode, switch the mode selector switch to Ω position.

Pressing the bottom trigger causes the tool to rotate clockwise as usual. Simultaneously pressing the top and bottom triggers causes the tool to immediately switch to oscillating mode. The clamped tool oscillates clockwise/anticlockwise. The speed can be changed by means of the bottom trigger. After the top trigger is released, the tool returns to normal clockwise rotation.

Precautions:

- **Oscillating mode may only be used with the following attachments:**
 - AO/ASIF Quick Coupling (05.001.250)
 - Chuck (05.001.252, 05.001.253)
 - Quick Coupling for Kirschner Wires (532.022)
- **Do not use the oscillating mode with the oscillating saw attachments!**

Attachments

General Information

The Colibri II system offers a broad range of attachments.

A wide range of rotating attachments has color-coded rings, so that they can easily be identified. The table on the next page lists the different types of attachments available, the color coding as well as the speed of each attachment.

Mounting the attachments

Insert the attachment into the attachment coupling (Fig. 1). If the positioning pins do not lock into place right away, twist the attachment a bit to the right or left until it locks into the correct position. Check if the attachment is seated correctly by gently pulling on it.

Removing the attachments

Press the attachment release buttons **6** (see figure on page 7) simultaneously and remove the attachment from the coupling.

Precautions:

- **To prevent injury, the power tool must be switched off with the safety system (see page 7) during each manipulation.**
- **Only use original attachments and tools from Synthes. Damage that arises from using attachments and tools made by other manufacturers is not covered by the warranty.**
- **Never use an attachment in reverse mode with an old flexible shaft as this could cause serious injury to the patient.**
- **When the tool is not in use during the surgery, set the handpiece on its side to ensure that it does not fall over due to instability. Only place the power tool in an upright position on the sterile table to insert/remove attachments and cutting tools.**



Figure 1

	Article Number	Product	Speed	Color coding for speed
Drill Attachments	05.001.250	AO/ASIF Quick Coupling	1290 rpm	Blue
	05.001.252	Chuck (Drilling Speed), with Key, clamping range up to Ø 4.0 mm	1290 rpm	Blue
	05.001.253	Chuck (Drilling Speed), with Key, clamping range up to Ø 7.3 mm	1290 rpm	Blue
Screw Attachments	05.001.251	Screw Attachment with AO/ASIF Quick Coupling	350 rpm	Red
Ream Attachments	532.017	AO/ASIF Quick Coupling for Medullary Reaming	350 rpm	Red
	532.018	Hudson Quick Coupling for Medullary Reaming	350 rpm	Red
	532.019	Trinkle Quick Coupling for Medullary Reaming	350 rpm	Red
	532.020	Trinkle Quick Coupling, modified, for Medullary Reaming	350 rpm	Red
	532.015	Quick Coupling for DHS/DCS triple reamers	350 rpm	Red
	05.001.254	Chuck (Reaming Speed), with Key, clamping range up to Ø 7.3 mm, with reverse motion	350 rpm	Red
Other Rotating Attachments	532.011	Mini Quick Coupling	3500 rpm	None
	532.012	J-Latch Coupling	3500 rpm	None
	532.022	Quick Coupling for Kirschner Wires	875 rpm	None
	05.001.187	Burr Attachment	17500 rpm	None
	511.300	Radiolucent Drive with Attachment 05.001.250	1250 rpm	None
Saw Attachments	532.021	Oscillating Saw Attachment	17500 osc./min	None
	532.023	Oscillating Saw Attachment II (Crescentic Technique)	17500 osc./min	None
	532.026	Large Oscillating Saw Attachment	17500 osc./min	None
Other Attachments	511.773	Torque Limiter, 1.5 Nm, for AO/ASIF Quick Coupling	–	N/A*
	511.776	Torque Limiter, 0.8 Nm, with AO/ASIF Quick Coupling	–	N/A*
	511.777	Torque Limiter, 0.4 Nm, with AO/ASIF Quick Coupling	–	N/A*

* Color coding on Torque Limiters does not refer to speed.

Technical data is subject to tolerances. Specifications are approximate and may vary from one device to another or as a result of power supply fluctuations.

Drill Attachments

AO/ASIF Quick Coupling (05.001.250)

For tools with an AO/ASIF coupling shaft.

Mounting and removing the tools

Insert the tool into the attachment from the front applying slight pressure and turning slightly. It is not necessary to operate the coupling sleeve of the attachment.



To disconnect, push the coupling sleeve of the attachment back and remove the tool.

Chucks

There are two Drill Attachments Chucks available as Drill Attachments for the Colibri II system.

Article number	Clamping range	Spare key	Comments
05.001.252	0.5–4.0 mm	310.932	For drilling
05.001.253	0.5–7.3 mm	510.191	For drilling

Inserting cutting tools

Open the jaws of the Chuck using the appropriate key or by hand. Insert the shaft of the tool into the open drill chuck and close it by twisting the chuck. Make sure that the shaft lies central to the three jaws. Tighten the drill chuck with the key. Make sure that the teeth of the key engage correctly in the toothed rim of the chuck.



Removing cutting tools

Open the Chuck with the key and remove the tool.

Precautions:

- Check the cutting tool for wear and /or damage after each use and replace if necessary.
- To ensure good fixation of the tools, make sure the toothed rims on the drill chuck and key are not worn.



Warning: Do not use the Colibri II for acetabular reaming.

Screw Attachments

Screw Attachment, with AO/ASIF Quick Coupling (05.001.251)

Mounting and removing the tools

Insert the tool into the attachment from the front by applying slight pressure and turning slightly. It is not necessary to operate the coupling sleeve of the attachment.

To disconnect, push the coupling sleeve of the attachment back and remove the tool.

Note: Theoretically, it is also possible to use the AO/ASIF Quick Coupling (05.001.250) to insert screws. However, the Screw Attachment (05.001.251) has a lower speed and a higher torque and is therefore more suitable. Screws with a large diameter may not be able to be inserted with the AO/ASIF Quick Coupling as the torque may not suffice.

Precautions:

- Care should be taken when inserting screws with the drive unit.
- Never fully insert screws with the drive unit. The last turns or locking should always be done manually.
- Always use an appropriate torque limiting attachment when putting locking screws into a locking plate.
- The attachment is also suitable for application at a lower rpm and/or higher torque.



Ream Attachments

All Colibri II Ream Attachments provide an approximative maximal torque of 7.5 Nm (with battery 532.103).

Quick Couplings for Medullary Reaming

AO/ASIF Quick Coupling (532.017)

Hudson Quick Coupling (532.018)

Trinkle Quick Coupling (532.019)

Trinkle Quick Coupling, modified (532.020)

The Quick Couplings for Medullary Reaming enable the use of flexible shafts with the appropriate coupling geometry. Reverse motion, which can damage the flexible shafts, is prevented by a special mechanical system.

Inserting cutting tools into the coupling

Maneuver the unlocking ring on the attachment backward and insert the tool (such as a drill bit) while rotating it slightly until it locks into place. Release the ring. Check if the tool is seated correctly in the coupling by gently pulling on it.

Removing cutting tools

Push the unlocking ring on the attachment backward and remove the tool.



Quick Coupling for DHS/DCS Triple Reamers (532.015)

For DHS/DCS Triple Reamers; can also be used to open the medullary cavity with most of the Synthes nailing systems.

Mounting and removing the tools

To connect the tool, push the coupling sleeve forward and then introduce the tool while turning slightly. To disconnect, push the coupling sleeve of the attachment forward and remove the tool.



Chucks

There are two chucks available as Ream Attachments for the Colibri II system.

Article number	Clamping range	Spare key	Comments
05.001.254	0.5–7.3 mm	510.191	For drilling and medullary reaming, with reverse motion

Inserting cutting tools

Open the jaws of the chuck using the appropriate key or by hand. Insert the shaft of the tool into the open drill chuck and close it by twisting the chuck. Make sure that the shaft lies central to the three jaws. Tighten the drill chuck with the key. Make sure that the teeth of the key engage correctly in the toothed rim of the chuck.

Removing cutting tools

Open the chuck with the key and remove the tool.

Precautions:

- During reaming procedure, high torque values must be provided by the power tool to the reaming head to allow efficient bone removal. In cases where the reaming head suddenly is blocked, these high torque values can be transferred onto the user's hand, wrist and /or the patient's body. In order to prevent injuries it therefore is essential that:
 - the power tool is held in an ergonomic position with a firm grip.
 - if the reamer head blocks, the speed trigger is released immediately.
 - the correct function of the speed trigger (immediate stop of the system when the trigger is released) is checked before the reaming process.
- Use the Chuck with Reverse motion (05.001.254) only with tools that are approved for such use. Otherwise, the tool may break with subsequent damage.
- Check the cutting tool for wear und / or damage after each use und replace if necessary.
- To ensure good fixation of the tools, make sure the toothed rims on the drill chuck und key are not worn.



Warning: Do not use the Colibri II for acetabular reaming.

Other Rotating Attachments

Mini Quick Coupling (532.011)

J-Latch Coupling (532.012)

For tools with a Mini Quick or J-Latch coupling shaft.

Mounting and removing the tools

To connect the tool, pull the coupling sleeve back and then introduce the tool while rotating slightly.

To disconnect, push the coupling sleeve of the attachment back and remove the tool.



Quick Coupling for Kirschner Wires (532.022)

Kirschner Wires of any length with a diameter of 0.6–3.2 mm can be used with the Quick Coupling for Kirschner Wires.

1. Adjust the Kirschner Wire diameter according to the label on the adjusting sleeve **K**. Slightly press the adjusting sleeve axially against the handpiece and rotate the sleeve.
2. Apply a slight amount of pressure to insert the Kirschner Wire from the front into the cannulation **J**. The wire is held automatically.
3. Adjust the working length by pulling on the wire.
4. To affix the wire, pull the tension lever **L** against the tool with your little finger and ring finger. Only pull the tension lever against the tool as much as necessary. The clamping force can be varied by pulling and releasing the clamping lever.
5. Insert the wire into the bone. Apply the clamping force as long as the wire is advanced.
6. To adjust the grip on the wire, reduce the clamping force and move the tool to the desired length. Rec-lamp the wire by pulling on the tension lever.

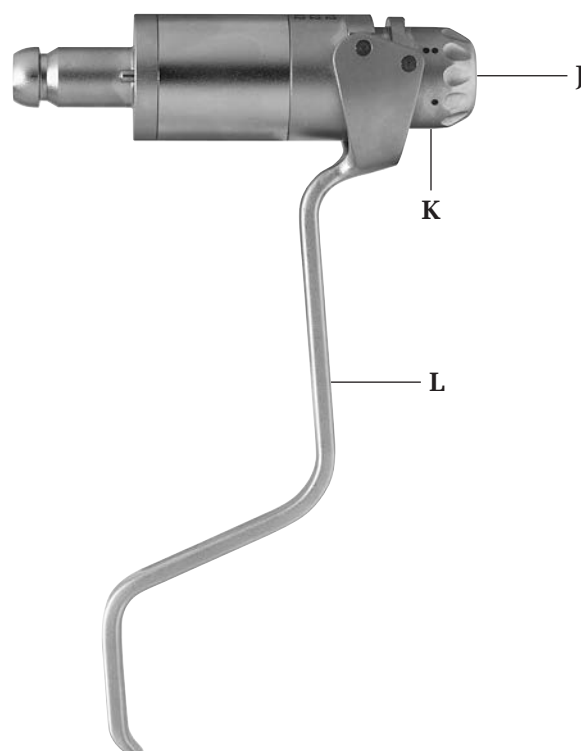

Radiolucent Drive (511.300)

The Radiolucent Drive can be used with the Colibri II in combination with the AO/ASIF Quick Coupling (05.001.250) and the Adapter for the Radiolucent Drive (532.031).

Coupling the Radiolucent Drive to the power tool

Connect the AO/ASIF Quick Coupling to the Colibri II and the adapter to the Quick Coupling. Position the Radiolucent Drive as far as it will go over the Quick Coupling and the adapter and rotate it into the desired working position. Support the drive with your free hand.

**Inserting the drill bit**

Pull the ring on the attachment forward and position the drill bit inside the coupling as far as it can go while rotating it slightly. Engage the ring on the attachment back in order to fix the drill. Check if the drill bit is seated correctly by gently pulling on it.

Removing the drill bit

Follow the same procedure in reverse order.



Using the Radiolucent Drive

Before positioning the Radiolucent Drive, align the image intensifier until the distal locking hole of the medullary nail is round and easily visible.

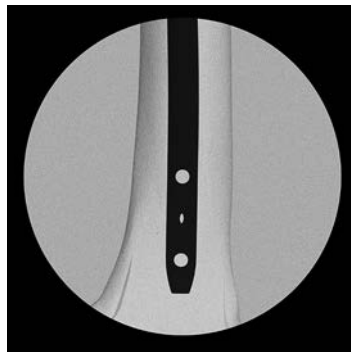

After the incision, position the Radiolucent Drive and center the drill bit tip over the locking hole. On the monitor of the image intensifier, you can see both the drill bit and the target rings of the drive.

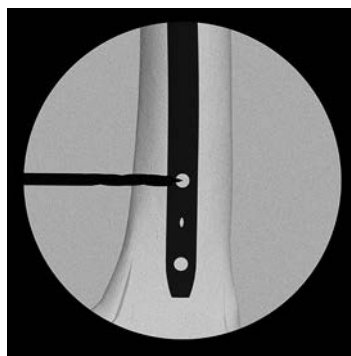

Swing the drive up and center it precisely so that the drill bit appears as a round point and the locking hole is visible around it. The target ring also assists the centering. The locking hole can now be drilled directly.

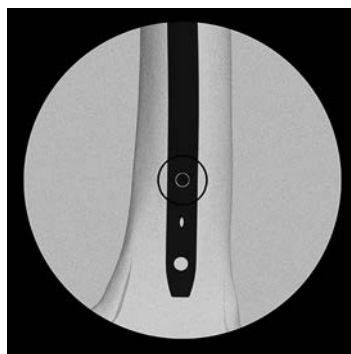

Precautions:

- Grip the coupled Radiolucent Drive tightly when switching on the power tool, particularly if the power tool is held face down.
- Only special 3-flute spiral drill bits can be used. Your Synthes representative will provide you with additional information on which drill bits can be used.
- Handle the Radiolucent Drive with great care. Do not allow contact between the drill bit and the medullary nail.
- Depending on the setting of the image intensifier, a zone may appear in the rear of the Radiolucent Drive that is not radiolucent. However, this does not inhibit aiming and working with the device.
- To protect the gears, the Radiolucent Drive is equipped with a slip clutch that disengages in case of an overload and emits an audible rattling noise.
- The following procedures can cause an overload:
 - Correcting the drilling angle when the cutting edges of the drill bit are completely in the bone.
 - Hitting the nail with the drill bit.
- Drilling can be continued after having made the following corrections:
 - Correcting the drilling angle: Remove the drill bit until the flutes are visible and then restart the drilling.
 - Hitting a nail: Remove the drill bit until the flutes are visible and re-aim the drill bit or exchange the drill bit if necessary.

Burr Attachment (05.001.187)

The Burr Attachment is size M. It can be used with Burrs for Burr Attachments of the Electric Pen Drive and Air Pen Drive systems. It is compatible with burr types M and L, but it is recommended to use burrs of size M.

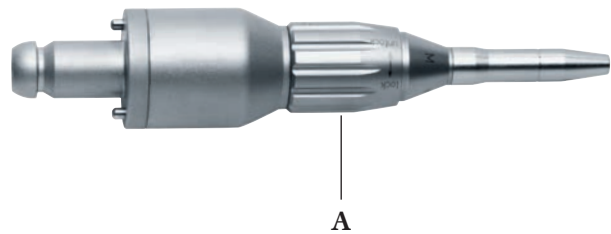

Changing burrs

1. Lock unit.
2. Turn the release sleeve for burrs **A** until it engages in the UNLOCK position and remove the tool.
3. Insert the new tool as far as possible, turn it slightly until it locks in place and then turn the release sleeve for burrs into the LOCK position until it engages. With burrs of size M, the burr is correctly clamped when the marking M on the burr shank is no longer visible.

Information on handling burrs

Synthes recommends using a new sterile burr for each operation. This prevents health risks to the patient.

Used burrs present the following risks:

- Necrosis due to excess heat
- Longer cutting time due to reduced performance of the burr

Precautions:

- **Burrs must be cooled with irrigation fluid to prevent heat necrosis.**
- **The attachments may only be used with the burrs intended for this purpose or one size above (attachment is size M, please therefore only use burrs of size M or L).**
- **Synthes recommends wearing protective goggles when working with burrs.**

Saw Attachments

Precaution: Even if lines and measurements are indicated on the saws, these articles should not be used as measuring instruments.

Oscillating Saw Attachment (532.021)

Positioning the saw attachment

The attachment can be locked in eight different positions (45° steps) when coupled: Lock the machine, shove the sliding sleeve **N** toward the saw blade coupling and rotate the attachment into the desired position (Fig. 1).

Precaution: To prevent injury, always grip the saw attachment with the inserted saw blade from the direction of the machine.

Changing the saw blade (Fig. 2)

1. Lock the machine.
2. Pull the locking knob **O** down and turn it counter-clockwise.
3. Lift and remove the saw blade.
4. Use a slight amount of pressure to insert the new saw blade and turn it to the desired position. The desired positions can be offset from each other at 45° angles.
5. Place your thumb on the saw blade coupling to hold the saw blade and turn the locking mechanism clockwise until the saw blade is fixed.
6. Unlock the power tool.

Precaution: Saw blades labeled “Single Use” should not be reused.

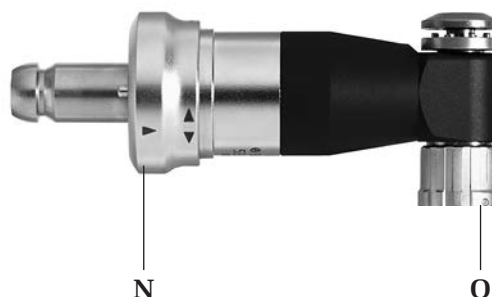

Figure 1



Figure 2



Figure 3

Positioning the saw blade

The saw blade can be adjusted in the desired position vertically and horizontally at an angle of 45° (see the earlier sections “Positioning the saw attachment” and “Changing the saw blade”).

Using the oscillating saw attachment

The saw blade must already be oscillating when the saw is applied to the bone. Do not apply strong pressure to the saw blade as this will delay the cutting process and the saw teeth will catch in the bone. Optimal saw performance is achieved by moving the power tool slightly back and forth in the plane of the saw blade so that the blade oscillates beyond the bone on both sides. Very precise cuts can be made when the saw blade is guided steadily. Imprecise cuts arise due to used blades, excess pressure or jamming the saw blade.

Instructions for handling the saw blades

Synthes recommends using a new blade for each operation to ensure that the saw blade is optimally sharpened and clean. The following risks are associated with used blades:

- Necrosis caused by excessive heat build-up
- Infection caused by residue
- Extended cutting time due to poor saw performance

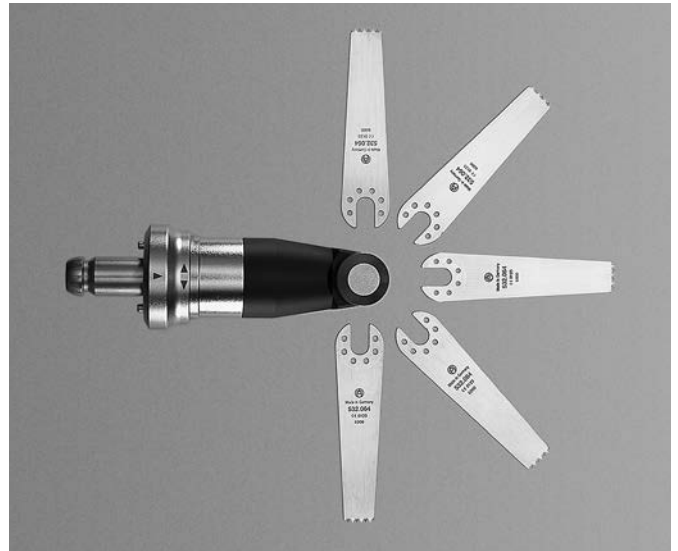

Figure 4

Oscillating Saw Attachment II (Crescentic Technique) (532.023)

The Oscillating Saw Attachment II is essentially designed for use with semicircular saw blades (for example 03.000.313S) guided by a 1.6 mm Kirschner Wire. It can also be used with saw blades with a shaft extension (for example 03.000.340S) for reaching difficult-to-access sites (such as intraoral).

Inserting the saw blade

Pull the saw blade coupling toward the handpiece and insert the saw blade while rotating it slightly until it locks into the saw attachment coupling. Release the saw blade coupling and check that the saw blade is correctly fixed by gently pulling on the saw blade.

Removing the saw blade

Pull the saw blade coupling towards the handpiece to release the saw blade.

Precautions:

- The saw attachments may only be used with the handpiece in the ON mode (Ω).
- Do not use the saw attachments in oscillating drilling mode (Ω).
- The appropriate surgical technique (036.000.907) should be observed to ensure the safe and successful application of the Crescentic Technique.

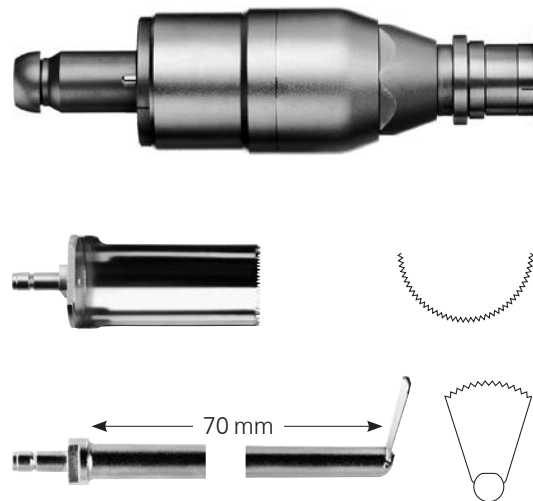

Large Oscillating Saw Attachment (532.026)

The Large Oscillating Saw Attachment is a specially designed saw attachment for performing a crescentic saw cut, e.g. while performing a Tibial Plateau Leveling Osteotomy in the canine proximal tibia. The attachment is approved for use in both humans and animals.



Inserting the saw blade

Insert the saw blade in the saw blade coupling and tighten the screw in the saw blade with the key (532.027) that was delivered with the attachment or use a T15 StarDrive screwdriver (e.g. 314.115).



Check that the saw blade is correctly in place and properly tightened.

Mounting the saw attachment

Make sure that the mode switch of the handpiece is in the OFF position and that the locking sleeve on the saw attachment is set to the unlock position . Insert the saw attachment in any position into the attachment coupling of the handpiece until it locks into place. To prevent vibrations during operation and to increase the sawing capacity, additional manual tightening of the attachment onto the handpiece is required. Turn the locking sleeve into the lock direction until you feel that the coupling pins engage into the handpiece (approx. half a revolution).



Precautions:

- **The Large Oscillating Saw Attachment may only be used with the handpiece in the ON mode. Do not operate the Large Oscillating Saw attachment in the oscillating drilling mode ().**
- **Avoid applying high pressure onto the saw blade.**

Removing the saw attachment

Turn the locking sleeve to the unlock position  before pushing both release buttons on the handpiece.

Other Attachments

Torque Limiter 1.5 Nm (511.773)

Torque Limiter 0.8 Nm (511.776)

Torque Limiter 0.4 Nm (511.777)

Note: For any information about these Torque Limiters (511.773, 511.776 and 511.777), please refer to the specific Instructions for Use for Torque Limiters (SM_708376). This document specifically describes the correct usage and reprocessing of these articles.

Coupling the Torque Limiter to the power tool

Torque Limiters can be connected to the Colibri II using the AO/ASIF Quick Coupling (05.001.251).

Note: The Torque Limiter must be annually serviced and recalibrated by Synthes. Note the information on the test certificate in the packaging. The user is responsible for following the calibration schedule.



Care and Maintenance

General Information

Power tool units and attachments are frequently exposed to high mechanical loads and shocks during use and should not be expected to last indefinitely. Proper handling and maintenance help extend the useful life of surgical instruments.

Gentle care and maintenance with proper lubrication can substantially increase the reliability and life of the system components.

Synthes power tools must be serviced and inspected annually by the original manufacturer or an authorized site. The manufacturer assumes no warranty for damages arising from improper use, neglected or unauthorized servicing.

For more information about Care and Maintenance, please refer to the Colibri II Care and Maintenance Poster (DSEM/PWT/0417/0145).

Precautions:

- **Reprocessing must be performed immediately after each use.**
- **Cannulations, unlocking sleeves and other narrow sites require special attention during cleaning.**
- **Cleaners with a pH of 7–9.5 are recommended. The use of cleaners with higher pH-values can – depending on the cleaner – cause dissolution of the surface of aluminum, titanium and its alloys, plastics or compound materials. The use of such cleaners should be subject to the data regarding material compatibility in the corresponding data sheet. At pH values higher than 11, the surface of stainless steel can be affected. For detailed information about material compatibility, refer to the document “Important Information” at <http://emea.depuyshnthes.com/hcp/reprocessing-care-maintenance>. Please refer to the chapter “Material Compatibility of Synthes Instruments in Clinical Processing”. Concerning the clinical reprocessing of the Colibri II system please refer to the following section of this document.**
- **Follow the enzymatic cleaner instructions for use for correct dilution/concentration, temperature and water quality. Devices should be cleaned in a fresh, newly-made solution.**
- **Detergents used on the products will be in contact with the following materials: stainless steel, aluminum, plastic and rubber seals.**
- **Never immerse the handpiece, batteries, battery casing or attachments in aqueous solutions or in an ultrasonic bath. Do not use pressurized water as this will cause damage to the system. The aseptic transfer is detailed on page 9ff. Alternatively for the Li-**

Ion battery 532.103 follow the guidelines provided in the STERRAD/V-PRO sterilization guide (DSEM/PWT/0591/0081). No other sterilization methods are allowed. Additionally, the batteries must never be washed, rinsed or dropped. This will destroy the battery with possible secondary damage.

- **This Care and Maintenance section does not apply to articles 511.773, 511.776 and 511.777. Please refer to the specific Instructions for Use for Torque Limiters (SM_708376) to learn more about the reprocessing of these articles.**
- **Synthes recommends using new sterile cutting tools for each operation. Refer to “Clinical Processing of Cutting Tools” (DSEM/PWT/0915/0082) for detailed clinical processing instructions.**

Unusual Transmissible Pathogens

Surgical patients identified as at risk for Creutzfeldt-Jakob disease (CJD) and related infections should be treated with single-use instruments. Dispose of the instruments used or suspected of use on a patient with CJD after surgery and/or follow the current national recommendations.

Notes:

- **The clinical processing instructions provided have been validated by Synthes for preparing a non-sterile Synthes medical device; these instructions are provided in accordance with ISO 17664:2004 and ANSI/AAMI ST81:2004.**
- **Consult the national regulations and guidelines for additional information. In addition, compliance with internal hospital policies and the procedures and recommendations of manufacturers of detergents, disinfectants and any clinical processing equipment is additionally required.**
- **Cleaning Agent Information: Synthes used the following cleaning agents during validation of these reprocessing recommendations: neutral pH enzymatic detergents (e. g. Prolystica 2X Concentrate Enzymatic Cleaner). These cleaning agents are not listed in preference to other available cleaning agents which may perform satisfactorily.**
- **It remains the responsibility of the processor to ensure that the processing performed achieves the desired result using the appropriate properly installed, maintained and validated equipment, materials and personnel in the processing unit. Any deviation by the processor from the instructions provided should be properly evaluated for effectiveness and potential adverse consequences.**

Care and Maintenance

Cleaning and Disinfection

Preparation Prior to Reprocessing

Disassembly

Disassemble device if applicable. Remove all instruments and attachments from the power tool. Remove the battery casing from the handpiece and then remove the battery itself.

Cleaning and Disinfection of Batteries and Charger

1. To clean the batteries and the charger, wipe them off with a clean, soft and lint-free cloth dampened with deionized water and dry prior to processing (Figs 1 and 2).

2. To disinfect the batteries and the charger, wipe them off with a clean, soft and lint-free cloth dampened with a minimum of 70% alcohol-based disinfectant for thirty (30) seconds. A disinfectant that is VAH listed, EPA registered or locally recognized is recommended. This step has to be repeated two (2) additional times using a new, clean, soft and lint-free cloth dampened with a minimum 70% alcohol-based disinfectant each time. Follow the instructions provided by the manufacturer of the disinfectant.

Precautions:

- **Do not use solvents to disinfect the batteries. Battery poles must not contact water or solvents: danger of short circuiting.**
- **Do not to spray the contacts or touch both contacts at the same time with the damp cloth due to danger of short circuiting.**
- **Inspect battery for cracks and damage.**

Return batteries to charger (05.001.204) after each use (Fig. 3). Upon completion of charging the battery, wipe the battery with a minimum 70% alcohol-based disinfectant prior to returning to use.

The aseptic transfer is detailed on page 9ff. Alternatively for the Li-Ion battery 532.103 follow the guidelines provided in the STERRAD/V-PRO sterilization guide (DSEM/PWT/0591/0081). No other sterilization methods are allowed.

Cleaning and Disinfection of handpieces, battery casings, sterile covers and attachments

Handpieces, battery casings, sterile covers and attachments must be processed using

- a) manual cleaning and/or
- b) automated cleaning with manual pre-cleaning.

Note: Clean all movable parts in opened position.



Figure 1



Figure 2



Figure 3

Cleaning and Disinfection

Manual Cleaning Instructions

Important:

- The Colibri II batteries must not be cleaned following the Manual Cleaning Instructions.
- This section does not apply to articles 511.773, 511.776 and 511.777. Please refer to the specific Instructions for Use for Torque Limiters (SM_708376) to learn more about the reprocessing of these articles.

1. **Remove debris.** Rinse the device under running cold tap water for a minimum of 2 minutes. Use a sponge, soft lint-free cloth or soft-bristled brush to assist in removing gross soil. For cannulations of the handpiece and attachments, the cleaning brush (519.400) shown below should be used.



Note:

- Brushes and other cleaning tools shall be either single use items or, if reusable, be decontaminated at least daily using a solution as detailed in section “3. Spray and wipe”.
- Brushes shall be inspected before daily use and discarded if they have degraded to the point where they may scratch instrument surfaces or be ineffective due to worn or missing bristles.

Precautions:

- Do not immerse the handpiece, batteries, battery casings or attachments in aqueous solutions or in an ultrasonic bath.
- Do not use pressurized water as this will cause damage to the system.
- Do not use pointed objects for cleaning.

2. **Manipulate moving parts.** Manipulate all moving parts such as the triggers, sleeves and switches under running tap water to loosen and remove gross debris.

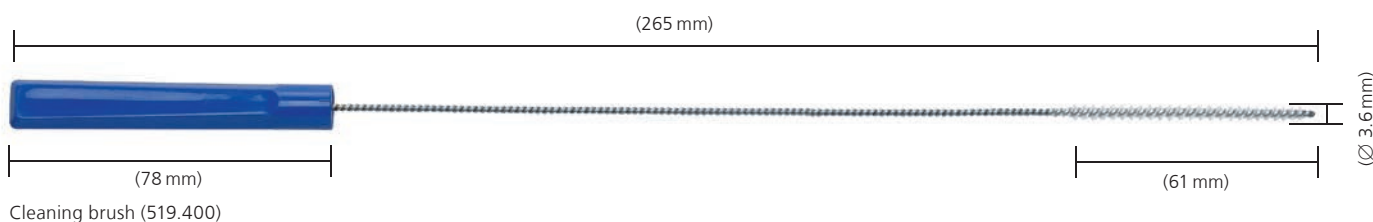

3. Spray and wipe. Spray and wipe the device using a neutral pH enzymatic solution for a minimum of 2 minutes. Follow the enzymatic detergent manufacturer's directions for correct temperature, water quality (i.e. pH, hardness) and concentration/dilution.



4. Rinse with tap water. Rinse device with cold tap water for a minimum of 2 minutes. Use a syringe or pipette to flush lumens and channels.

5. Clean with detergent. Clean the device manually under running warm water using an enzymatic cleaner or detergent for a minimum of 5 minutes. Manipulate all moving parts under running water. Use a soft-bristled brush and/or soft lint-free cloth to remove all visible soil and debris. Follow the enzymatic cleaner or detergent manufacturer's instructions for use for correct temperature, water quality and concentration/dilution.



6. Rinse with tap water. Rinse the device thoroughly using cool to lukewarm running water for a minimum of 2 minutes. Use a syringe, pipette or water jet to flush lumens and channels. Actuate joints, handles and other movable device features in order to rinse thoroughly under running water.



7. Wipe/Spray disinfection. Wipe off or spray the surfaces of the devices with a minimum of 70% alcohol-based disinfectant.

8. Visually inspect device. Inspect the cannulations, coupling sleeves, etc. for visible soil. Repeat steps 1–8 until no visible soil remains.

9. Final rinse with de-ionized/purified water.

Final rinse with de-ionized or purified water for a minimum of 2 minutes.



- 10. Dry.** Dry device using a soft lint-free cloth or medical grade compressed air. If smaller devices or cannulations contain residual water, blow dry with medical grade compressed air.



Cleaning and Disinfection

Automated Cleaning Instructions with Manual Pre-Cleaning

Important:

- The Colibri II batteries must not be cleaned following the Mechanical/Automated Cleaning Instructions with Manual Pre-Cleaning.
- This section does not apply to articles 511.773, 511.776 and 511.777. Please refer to the specific Instructions for Use for Torque Limiters (SM_708376) to learn more about the reprocessing of these articles.
- Manual pre-cleaning prior to automated cleaning/disinfection is important to ensure that cannulations and other difficult to access areas are clean.
- Alternative cleaning/disinfection procedures other than in the procedure described below (including manual precleaning) have not been validated by Synthes.

1. **Remove debris.** Rinse the device under running cold tap water for a minimum of 2 minutes. Use a sponge, soft lint-free cloth or soft-bristled brush to assist in removing gross soil. For cannulations of the handpiece and attachments, the cleaning brush (519.400) shown below should be used.



Note:

- Brushes and other cleaning tools shall be either single use items or, if reusable, be decontaminated at least daily using a solution as detailed in section “3. Spray and wipe”.
- Brushes shall be inspected before daily use and discarded if they have degraded to the point where they may scratch instrument surfaces or be ineffective due to worn or missing bristles.

Precautions:

- Do not immerse the handpiece, batteries, battery casings or attachments in aqueous solutions or in an ultrasonic bath.
 - Do not use pressurized water as this will cause damage to the system.
 - Do not use pointed objects for cleaning.
2. **Manipulate moving parts.** Manipulate all moving parts such as the triggers, sleeves and switches under running tap water to loosen and remove gross debris.

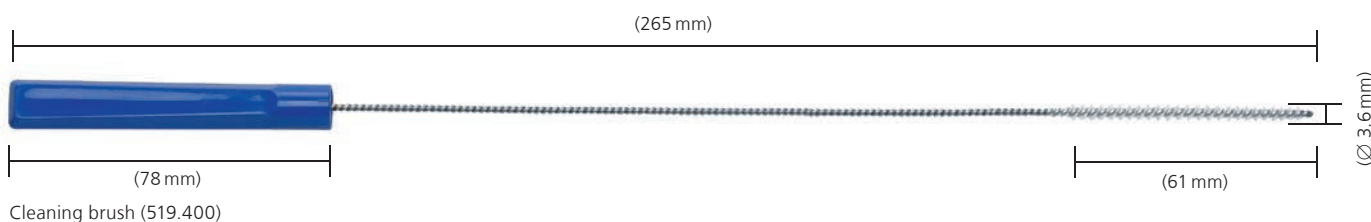

3. Spray and wipe. Spray and wipe the device using a neutral pH enzymatic solution for a minimum of 2 minutes. Follow the enzymatic detergent manufacturer's directions for correct temperature, water quality (i.e. pH, hardness) and concentration/dilution.



4. Rinse with tap water. Rinse device with cold tap water for a minimum of 2 minutes. Use a syringe or pipette to flush lumens and channels.

5. Clean with detergent. Clean the device manually under running warm water using an enzymatic cleaner or detergent for a minimum of 5 minutes. Manipulate all moving parts under running water. Use a soft-bristled brush and/or soft lint-free cloth to remove all visible soil and debris. Follow the enzymatic cleaner or detergent manufacturer's instructions for use for correct temperature, water quality and concentration/dilution.



6. Rinse with tap water. Rinse the device thoroughly using cool to lukewarm running water for a minimum of 2 minutes. Use a syringe, pipette or water jet to flush lumens and channels. Actuate joints, handles and other movable device features in order to rinse thoroughly under running water.



7. Visually inspect device. Inspect the cannulations, coupling sleeves, etc. for visible soil. Repeat steps 1–7 until no visible soil remains.

8. Load washing basket. Please use the specially designed tray for machine washing as supplied by Synthes (68.001.610). Follow the loading plan as shown below or refer to the loading plan (DSEM/PWT/1116/0129). Ensure that the attachments are positioned in an upright position as shown and fully opened. Ensure that the water can flow off any surfaces. Damage due to improper reprocessing is not covered by the warranty.

Note: A lid (68.001.602) is available for the washing basket. This can be used for sterilization, but is not required for machine washing.

Warning: Do not wash the system in the Synthes Vario Cases (68.001.255, 68.001.253).

**Dimensions of the Washing Basket
(Length × Width × Height):**

Washing Basket without Lid: 500 × 250 × 112 mm
 Washing Basket with Lid: 504 × 250 × 150 mm

**68.001.610
 Washing Basket, size 1/1, for Colibri (II) and Small Battery Drive (II)**

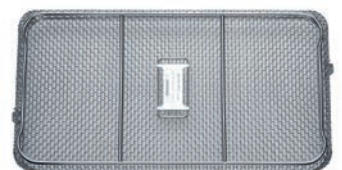
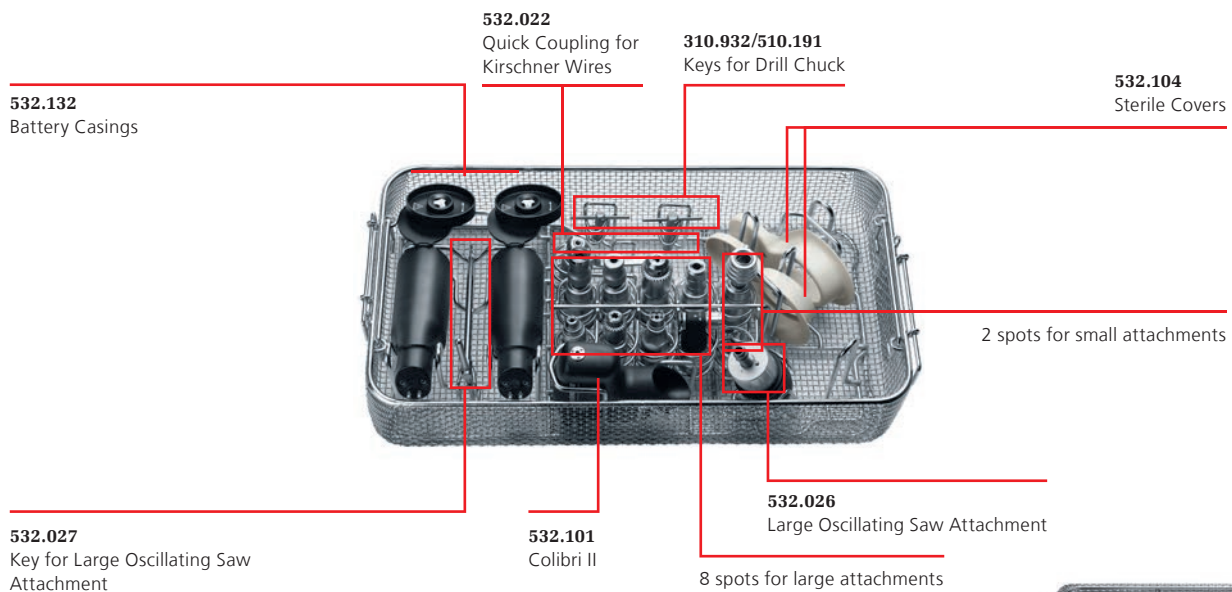

68.001.602
 Lid for Washing Basket size 1/1

9. Automated cleaning cycle parameters

Note: The washer/disinfector should fulfill the requirements as specified in ISO 15883.

Step	Duration (minimum)	Cleaning instructions
Rinse	2 minutes	Cold tap water
Pre-wash	1 minute	Warm water (≥ 40 °C); use detergent
Cleaning	2 minutes	Warm water (≥ 45 °C); use detergent
Rinse	5 minutes	Rinse with de-ionized (DI) or purified water (PURW)
Thermal disinfection	5 minutes	Hot DI water, ≥ 93 °C
Dry	40 minutes	≥ 90 °C

10. Inspect the device. Remove all the devices from the washing basket. Inspect the cannulations, coupling sleeves, etc. for visible soil. If necessary, repeat the manual pre-clean/automated cleaning cycle. Confirm that all parts are completely dry.

Mechanical cleaning/disinfection is an additional stress for power equipment, especially for seals and bearings. Therefore, systems must be properly lubricated and regularly sent to be serviced (at least once per year).

Maintenance and Lubrication

The power tool and attachments should be regularly lubricated to ensure a long service life and smooth operation. It is recommended that the accessible moving parts of the handpiece, the battery casing and attachments are lubricated with 1 drop of Synthes special oil (519.970); distribute the oil by moving the components. Wipe off the excess oil with a cloth.

For detailed information, please refer to the Colibri II Care and Maintenance Poster (DSEM/PWT/0417/0145).

Lubricating the handpiece (Fig. 1 and 2)

- Lubricate the trigger shafts and then press the triggers several times.
- Lubricate the attachment release buttons and then press the buttons several times.
- Lubricate the battery casing release buttons from both the outside and inside (see Fig. 2) and then press the buttons several times.
- Lubricate the mode selector switch and then move it several times.
- Lubricate the attachment coupling.



Figure 1



Figure 2

Lubricating the battery casing (Fig. 3 and 4)

- Place oil on the seal of the cover and then evenly distribute the oil on the seal.
- Lubricate the lock, hinge and knob, then actuate it several times.



Figure 3

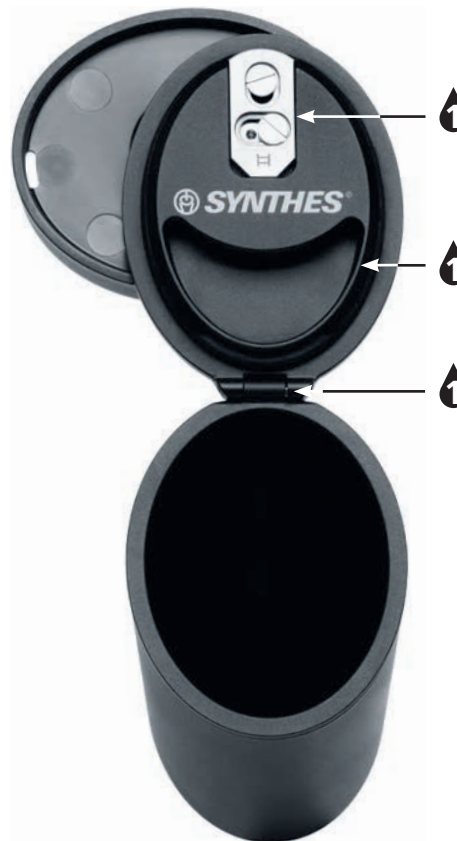

Figure 4

Attachments

All moving parts of all the attachments. Exception: the Radiolucent Drive (511.300) does not require lubrication.

Chuck (05.001.252–05.001.254)

Lubricate the jaws and toothed rim.

Open and close the drill chuck several times.

Quick Coupling for Kirschner Wires (532.022)

Lubricate the tension lever and clamping mechanism.

Hold the Quick Coupling up and add one drop of oil into the attachment hole and on the holder of the lever (Fig. 5).

Move the tension lever several times.

Mini Quick Coupling (532.011)

J-Latch Coupling (532.012)

AO/ASIF Quick Coupling (05.001.250/05.001.251)

Quick Coupling for DHS/DCS Triple Reamers (532.015)

Quick Coupling for Medullary Reaming (532.017/532.018/532.019/532.020)

Lubricate the unlocking ring. Move it back and forth several times.

Oscillating Saw Attachment (532.021)

Lubricate the locking mechanism and the saw blade coupling. Open and close the locking mechanism several times.

Oscillating Saw Attachment II (532.023)

Lubricate the unlocking sleeve, the tool holder and the attachment coupling. Move it back and forth several times.

Large Oscillating Saw Attachment (532.026)

First lubricate and then move all movable parts:

- Saw blade coupling (slot between the saw blade coupling and attachment)
- Locking sleeve of the attachment coupling (slots on both sides)
- Coupling pins
- Opening of the attachment coupling



Figure 5



Figure 6

Precautions:

- To ensure a long service life and reduce repairs, the power tool and all attachments must be lubricated after each use. Exception: The Radiolucent Drive (511.300) does not require lubrication.
- The power tool and accessories must only be lubricated with Synthes special oil (519.970). The composition of the vapor-permeable and biocompatible oil is optimized for the specific requirements of the power tool. Lubricants with other compositions can cause the power tool to jam and be toxic.
- Only lubricate the power tool and attachments when clean.

Care and Maintenance

Function Control

- Visually inspect for damage and wear (e.g. unrecognizable markings, missing or removed part numbers, corrosion, etc.).
- Check the handpiece controls for smooth operation and function.
- All movable parts should be moving smoothly. Check that the triggers do not remain blocked in the handpiece when pressing on them. Check that no residuals prevent the movable parts from moving smoothly.
- Check the coupling sleeves of the handpiece and attachments for smooth operation and check for function together with instruments such as cutting tools.
- Check instruments for correct adjustment and functioning prior to every use.
- Should the system have corroded parts, do not use it anymore and send it to the Synthes service center.

Packaging, Sterilization and Storage

Packaging

Put cleaned, dry products into their respective places in the Synthes case. Additionally, use an appropriate sterilization wrap or reusable rigid container system for sterilization, such as a Sterile Barrier System according to ISO 11607. Care should be taken in order to protect implants as well as pointed or sharp instruments from contact with other objects that may damage the surface or the Sterile Barrier System.

Sterilization

Note: For the sterilization of the Colibri II system, Synthes recommends the use of the specifically designed Synthes Vario Case (68.001.255) or of the specifically designed Washing Basket (68.001.610).

Synthes Colibri II system must be resterilized using validated steam sterilization methods (ISO 17665 or national standards). Synthes' recommendations for packed devices and cases are as follows.

Cycle type	Sterilization exposure time	Sterilization exposure temperature	Drying time
Saturated steam-forced air removal (pre-vacuum, minimum 3 pulses)	Minimum 4 minutes	Minimum 132 °C Maximum 138 °C	20–60 minutes
	Minimum 3 minutes	Minimum 134 °C Maximum 138 °C	20–60 minutes

Drying times generally range from 20 to 60 minutes due to differences in packaging materials (Sterile Barrier System, e.g., wraps or reusable rigid container systems), steam quality, device materials, total mass, sterilizer performance and varying cool down time.

Precautions:

- The aseptic transfer is detailed on page 9ff. Alternatively for the Li-Ion battery 532.103 follow the guidelines provided in the STERRAD/V-PRO sterilization guide (DSEM/PWT/0591/0081). No other sterilization methods are allowed.
- This section does not apply to articles 511.773, 511.776 and 511.777. Please refer to the specific Instructions for Use for Torque Limiters (SM_708376) to learn more about the sterilization of these articles.
- The following maximum values must not be exceeded: 138 °C over a maximum of 18 minutes. Higher values can damage the sterilized products.
- Do not accelerate the cooling process.
- Hot air, ethylene oxide, plasma and formaldehyde sterilization are not recommended.

Storage

Storage conditions for products labeled "STERILE" are printed on the packaging label.

Packaged and sterilized products should be stored in a dry, clean environment, protected from direct sunlight, pests and extremes of temperature and humidity. Use products in the order in which they are received ("first-in, first-out principle"), taking note of any expiration date on the label.

Repairs and Technical Service

The tool should be sent to the Synthes office for repair if it is faulty or malfunctions. Contaminated products have to run through the complete reprocessing procedure before being sent to the Synthes office for repair or technical service.

Please use the original packaging to send devices back to Synthes manufacturer or an authorized site.

Faulty devices must not be used. If it is no longer possible or feasible to repair the tool it should be disposed of (refer to the following section "Disposal").

Other than the above-mentioned care and maintenance, no further maintenance work is to be carried out independently or by third parties.

This system requires regular maintenance service, at least once a year, in order to maintain its functionality. This service has to be performed by the original manufacturer or an authorized site.

The manufacturer assumes no responsibility for damage resulting from neglected or unauthorized maintenance.

Please refer to the regulations for transporting Li-Ion batteries when returning them to the Synthes Service Center.

Disposal

In most cases, faulty tools can be repaired (refer to the previous section “Repairs and Technical Service”).



This device contains Lithium-Ion batteries that should be disposed of in an environmentally friendly manner. The European Battery Directive 2006/66/EC applies to this device.

Precautions:

- **Contaminated products have to run through the complete reprocessing procedure, so that there is no danger of infection in case of disposal.**
- **Always discharge the batteries and isolate the contacts before disposal.**

Warning: Risk of fire, explosion and burns. Do not disassemble, crush, heat above 60°C/140°F or incinerate the battery cells.

Please send tools that are no longer used to your local Synthes representative. This ensures that they are disposed of in accordance with the national application of the respective directive. The tool must not be disposed of with household waste.

Troubleshooting

Problem	Possible causes	Solution
Handpiece does not start up.	Battery is dead.	Charge the battery or replace it with a charged battery.
	The tool was not cooled off after sterilization.	Let the tool cool to room temperature.
	Mode selector switch is on OFF.	Turn the mode selector switch to ON or  .
	No contact between the handpiece and the battery pack.	Reinsert the battery pack or replace it.
Handpiece does not have enough power.	Battery is dead.	Charge the battery or replace it with a charged battery.
Machine stops suddenly.	The machine has overheated (overheating protection is activated).	Wait until the machine has cooled down.
	Battery is dead.	Charge the battery or replace it with a charged battery.
Attachments cannot be coupled to the unit.	The attachment coupling is blocked by deposits.	Remove solid objects with a pair of tweezers. Precaution: When removing objects, turn the mode selector switch to OFF.
Tool (saw blade, drill, burr etc.) can not be coupled or only with difficulty.	Shaft geometry of the attachment or tool is damaged.	Replace the attachment or tool or send it to your Synthes service office.
Oscillating saw attachment vibrates too much.	The saw blade locking mechanism is not tight.	Tighten the locking knob of the saw blade coupling.
	The mode selector switch is set to  .	Turn the mode selector switch to ON.
The Kirschner wire is inserted in the handpiece and cannot be moved forward.	The Kirschner wire was inserted from the rear.	Lock the machine by turning the mode selector switch to OFF. Remove the attachment, hold the drive shaft opening down and shake out the Kirschner wire.
Bone and tool heat up during surgery.	Cutting edges of the tool are blunt.	Replace the tool.

Problem	Possible causes	Solution
It is difficult to close the battery casing.	The battery casing seal has become dry from repeated cleaning.	Lubricate the seal as described on page 40.
The battery casing knob is difficult to turn.	The locking mechanism needs to be lubricated.	Lubricate the locking mechanism as described on page 40.
	The knob mechanism needs to be lubricated.	Lubricate the knob mechanism as described on page 40.
The triggers are difficult to move.	The trigger shafts need to be lubricated.	Lubricate the trigger shafts as described on page 39.
It is difficult to couple the battery casing to the machine.	The battery casing release buttons need to be lubricated.	Lubricate the battery casing release buttons as described on page 39.

If the recommended solutions do not work, send the power tool to your local Synthes service center.

For further technical questions or information on our services, please contact your Synthes representative.

System Specifications

Applicable Standards

The device meets the following standards

Medical electrical equipment – Part 1:
General requirements for basic safety and essential performance:

IEC 60601-1 (2012) (Ed. 3.1),
EN 60601-1 (2006) + A11 + A1 + A12,
ANSI/AAMI ES60601-1:2005/(R)2012,
CAN/CSA-C22.2 NO. 60601-1: 14







Medical electrical equipment – Part 1-2:
Collateral Standard: Electromagnetic disturbances –
Requirements and tests:
IEC 60601-1-2 (2014) (Ed. 4.0),
EN 60601-1-2 (2015)

Medical electrical equipment – Part 1-6:
Collateral Standard: Usability:
IEC 60601-1-6 (2010) (Ed. 3.0) + A1 (2010)



Medical General medical equipment as to electrical shock,
fire and mechanical hazards only in accordance with:
ANSI/AAMI ES60601-1 (2005) + AMD 1 (2012)
CAN/CSA-C22.2 No. 60601-1 (2014)

Environmental Conditions

	Operation	Storage
Temperature	 10 °C 50 °F 40 °C 104 °F	 10 °C 50 °F 40 °C 104 °F
Relative humidity	 30 % 90 %	 30 % 90 %
Atmospheric pressure	 500 hPa 0.5 bar 1060 hPa 1.06 bar	 500 hPa 0.5 bar 1060 hPa 1.06 bar
Altitude	0–5000 m	0–5000 m

Transportation*

Temperature	Duration	Humidity
–29 °C; –20 °F	72 h	uncontrolled
38 °C; 100 °F	72 h	85 %
60 °C; 140 °F	6 h	30 %

*products have been tested according to ISTA 2A

Warning: The machine must not be stored or operated in explosive atmospheres.

Technical Data**Colibri II: 532.101 Battery: 532.103 Battery Casing: 532.132**

Continuously adjustable speed:	0–3500 rpm
Weight (w. battery and battery casing):	925 g
Operating voltage:	14.4 VDC
Battery capacity:	1.2 Ah
Battery type:	Li-Ion
Cannulation:	Ø 3.2 mm
Empty battery charging time:	approx. 60 min
Degree of protection against electrical shock:	BF 
Degree of protection against the penetration of water:	IPX4
Noise level in the operating position (with attachment 05.001.250):	approx. 65 dB(A)

Technical data is subject to tolerances. Specifications are approximate and may vary from one device to another or as a result of power supply fluctuations.

Duty Cycles: Intermittent operation type S9, according to IEC 60034-1



	$X_{s\ on}$	$Y_{s\ off}$	Cycles
Drilling and tapping threads and reaming	60 sec	60 sec	9
Burring	60 sec	60 sec	3
Kirschner Wire setting	30 sec	60 sec	6
Sawing			
532.021	30 sec	60 sec	5
532.023	15 sec	60 sec	4
532.026	30 sec	60 sec	4
Other attachments	60 sec	60 sec	7

Generally, electrical systems can heat up if in constant use. For this reason, the handpiece and the attachment should be allowed to cool for at least 60 seconds ($Y_{s\ off}$) following the time of constant use ($X_{s\ on}$). After a certain amount of cycles (defined in the above table under "Cycles"), the handpiece and attachment should be allowed to cool down. If this is observed, the system will be prevented from overheating and possibly harming the patient or user. The user is responsible for the application and for turning off the system as prescribed. If longer periods of constant use are required, an additional handpiece and/or attachment should be used.

These recommendations for times of use for the attachments of the Colibri II have been determined under average load with an ambient air temperature of 20 °C (68 °F). Depending on the cutting tool used and on the load applied, the heat generation of the handpiece, attachment and/or cutting tool can vary. Always check the temperature of the system to prevent overheating and possibly harming the patient or user.

Precautions:

- Carefully observe the above recommended duty cycles.
- Always use new cutting tools to prevent the heating up of the system due to reduced cutting performance.
- Careful maintenance of the system will reduce heat development in the handpiece and the attachments.
- The Colibri II must not be stored or operated in an explosive atmosphere.
- Above mentioned duty cycles can be reduced due to higher loads applied and due to ambient air temperatures above 20 °C (68 °F). This needs to be taken into consideration during the planning of the surgical intervention.

Declaration of the emission sound pressure level and the power level according to the EU Directive 2006/42/EC Annex I

Measurements of the sound pressure level [LpA] are carried out in accordance with standard EN ISO 11202.

Measurements of the sound power level [LwA] are carried out in accordance with standard EN ISO 3746.

Information according to test protocol no.: 1711-5323/03.10, date of testing: 17 February 2011.

Handpiece	Attachment	Tool	Sound Pressure Level (LpA) in [dB(A)]	Sound Power Level (LwA) in [dB(A)]	Max. daily exposure time without hearing protection
Colibri II (532.101)	–	–	63	–	No limitation
	AO/ASIF Quick Coupling (05.001.250)	–	64	–	No limitation
	Oscillating Saw Attachment (532.021)	Saw blade (532.045)	73	–	No limitation
		Saw blade (532.067)	85	94	8 h
	Oscillating Saw Attachment (532.023)	Saw blade (03.000.313)	84	92	9 h 33 min
		Saw blade (03.000.316)	85	94	8 h
	Large Oscillating Saw Attachment (532.026)	Saw blade (03.000.394)	83	92	12 h
		Saw blade (03.000.396)	85	96	8 h

Declaration of vibration emission according to the EU Directive 2006/42/EC Annex I

The assessment of the vibration emissions [m/s²] is to be made to the hand-arm system according to EN ISO 8662.

Information according to test protocol no.: 1711-5323/03.10, date of testing: 18 February 2011.

Handpiece	Attachment	Tool	Vibration emission [m/s²]	Max. daily exposure
Colibri II (532.101)	–	–	< 2.5	8 h
	AO/ASIF Quick Coupling (05.001.250)	–	< 2.5	8 h
	Oscillating Saw Attachment (532.021)	Saw blade (532.045)	vertical: < 2.5	8 h
			horizontal: < 2.5	8 h
	Oscillating Saw Attachment (532.021)	Saw blade (532.067)	vertical: 3.73	3 h 35 min
			horizontal: 6.58	1 h 9 min
	Oscillating Saw Attachment (532.023)	Saw blade (03.000.313)	< 2.5	8 h
			Saw blade (03.000.316)	6.2
	Large Oscillating Saw Attachment (532.026)	Saw blade (03.000.394)	14.02	15 min
Saw blade (03.000.396)			18.44	8 min

Electromagnetic Compatibility

Accompanying Documents According to IEC 60601-1-2, 2014, ed. 4.0

Table 1: Emission

Guidance and manufacturer's declaration – electromagnetic emissions

The Synthes Colibri II system is intended for use in the electromagnetic environment specified below. The customer or user of the Synthes Colibri II system should ensure that it is used in such an environment.

Emission test	Compliance	Electromagnetic environment – guidance
RF emissions CISPR 11	Group 1	The Synthes Colibri II system uses RF energy only for its internal function. Therefore, its RF emissions are very low and are not likely to cause any interference in nearby electronic equipment.
RF emissions CISPR 11	Class B	The Colibri II system is suitable for use in professional healthcare facility environment but not in home healthcare or special environment.
Harmonic emissions IEC 61000-3-2	Not applicable	
Voltage fluctuations/ flicker emissions IEC 61000-3-3	Not applicable	

Table 2: Immunity (all devices)**Guidance and manufacturer's declaration – electromagnetic immunity**

The Synthes Colibri II system is intended for use in the electromagnetic environment specified below. The customer or user of the Synthes Colibri II system should ensure that it is used in such an environment.

Immunity test standard	IEC 60601 test level	Compliance level	Electromagnetic environment – guidance
Electrostatic discharge (ESD) IEC 61000-4-2	±8 kV contact ±15 kV air	±8 kV contact ±15 kV air	Floors should be wood, concrete or ceramic tile. If the floors are covered with synthetic material, the relative humidity should be at least 30%.
Electrical fast transient/burst IEC 61000-4-4	±2 kV for power supply lines	Not applicable	Mains power quality should be that of a typical commercial or hospital environment.
Surge IEC 61000-4-5	±1 kV line to line ±2 kV line to earth	Not applicable	Mains power quality should be that of a typical commercial or hospital environment.
Voltage dips, short interruptions and voltage variations on power supply lines IEC 61000-4-11	< 5% U_T (0.5 cycle) 40% U_T (5 cycles) 70% U_T (25 cycles) < 5% U_T for 5 s	Not applicable	Mains power quality should be that of a typical commercial or hospital environment.
Note: U_T is the AC mains voltage prior to the application of the test level.			
Power frequency (50/60 Hz) magnetic field IEC 61000-4-8	30 A/m	200 A/m	Power frequency magnetic fields should be at levels characteristic of a typical location in a typical commercial or hospital environment.

Table 3: Immunity (not life-supporting devices)**Guidance and manufacturer's declaration – electromagnetic immunity**

The Synthes Colibri II system is intended for use in the electromagnetic environment specified below. The customer or user of the Synthes Colibri II system should ensure that it is used in such an environment.

Precaution: Use of this equipment adjacent to or stacked with other equipment should be avoided because it could result in improper operation. If such use is necessary, this equipment and the other equipment should be observed to verify that they are operating normally.

Electromagnetic environment – guidance

Portable and mobile RF communications equipment should be used no closer to any part of the Synthes Colibri II system, including cables, than the recommended separation distance calculated from the equation applicable to the frequency of the transmitter.

Immunity test standard	IEC 60601 test level	Compliance level	Recommended separation distance ^a
Conducted RF IEC 61000-4-6	3 Vrms 150 kHz to 80 MHz	Not applicable	$d = 0.35 \sqrt{P}$ 150 kHz to 80 MHz
Radiated RF IEC 61000-4-3	3 V/m 80 MHz to 800 MHz	E1 = 10 V/m (measured 20 V/m) 80 MHz to 800 MHz	$d = 0.35 \sqrt{P}$ 80 MHz to 800 MHz
	3 V/m 800 MHz to 2.5 GHz	E2 = 10 V/m (measured 20 V/m) 800 MHz to 2.7 GHz	$d = 0.7 \sqrt{P}$ 800 MHz to 6.2 GHz

Where P is the maximum output power rating of the transmitter in watts (W) according to the transmitter manufacturer and d is the recommended separation distance in meters (m).

Field strengths from fixed RF transmitters as determined by an electromagnetic site survey,^b should be less than the compliance level in each frequency range.^c



Interference may occur in the vicinity of equipment marked with the following symbol:

Notes:

- At 80 MHz and 800 MHz, the higher frequency range applies.
- These guidelines may not apply in all situations. Electromagnetic propagation is affected by absorption and reflection from structures, objects and people.

^a Possible shorter distances of outside ISM bands are not considered to have a better applicability of this table.

^b Field strengths from fixed transmitters, such as base stations for radio (cellular/cordless) telephones and land mobile radios, amateur radio, AM and FM radio broadcast and TV broadcast cannot be predicted theoretically with accuracy. To assess the electromagnetic environment due to fixed RF transmitters, an electromagnetic site survey should be considered. If the measured field strength in the location in which the Synthes Colibri II system is used exceeds the applicable RF compliance level above, the Synthes Colibri II system should be observed to verify normal operation. If abnormal performance is observed, additional measures may be necessary, such as reorienting or relocating the Synthes Colibri II system.

^c Over the frequency range 150 kHz to 80 MHz, field strengths should be less than 10 V/m.

Table 4: Recommended separation distances

Recommended separation distances between portable and mobile RF communications equipment and the Synthes Colibri II system

The Synthes Colibri II system is intended for use in the electromagnetic environment in which radiated RF disturbances are controlled. The customer or user of the Synthes Colibri II system can help prevent electromagnetic interference by maintaining a minimum distance between portable and mobile RF communications equipment (transmitters) and the Synthes Colibri II system as recommended below, according to the maximum output power of the communication equipment.

Rated maximum output power of transmitter W	Separation distance according to frequency of transmitter m		
	150 kHz to 80 MHz $d = 0.35 \sqrt{P}$	80 MHz to 800 MHz $d = 0.35 \sqrt{P}$	800 MHz to 6.2 GHz $d = 0.7 \sqrt{P}$
0.01	4 mm	4 cm	7 cm
0.1	11 cm	11 cm	22 cm
1	35 cm	35 cm	70 cm
10	1.11 m	1.11 m	2.22 m
100	3.5 m	3.5 m	7 m

For transmitters rated at a maximum output power not listed above, the recommended separation distance d in meters (m) can be estimated using the equation applicable to the frequency of the transmitter, where P is the maximum output power rating of the transmitter in watts (W) according to the transmitter manufacturer.

Notes:

- At 80 MHz and 800 MHz, the separation distance for the higher frequency range applies.
 - These guidelines may not apply in all situations. Electromagnetic propagation is affected by absorption and reflection from structures, objects and people.
 - An additional factor of 10/3 is used in calculating the recommended separation distance to decrease the likelihood that mobile/portable communications equipment could cause interference if it is inadvertently brought into patient areas.
-

Additional Information

This section applies to the following articles:

532.002	Battery Casing for Nos. 532.001 and 532.010, standard
532.003	Battery for Nos. 532.001 and 532.010, 12V, standard
532.004	Sterile Cover for Nos. 532.001 and 532.010

The battery pack consisting of these three articles is compatible with the Colibri II handpiece (532.101) and can be used as an alternative to the 14.4-V Li-Ion (Lithium Ion) Colibri II battery pack (532.103, 532.132 and 532.104).

In addition to the information provided in the Colibri II IFU, this section provides specific information regarding the three above listed articles. Please consider both the IFU and this particular section when using this battery pack.

General Information

General Information and Precautions can be found on pages 3 and 4 of this IFU.

General symbols are listed on pages 5 and 6. An additional symbol that only applies to the battery (532.003) is the following:



Directive 2006/66/EC requires to implement recycling schemes to allow a separate collection for all types of batteries, accumulators and waste batteries and accumulators and to provide information about the heavy metals content of batteries. In this particular case, the rechargeable batteries do contain Cadmium (Cd). Therefore the Batteries, accumulators and waste batteries and accumulators shall not be disposed as unsorted municipal waste and shall undergo separate collection schemes.

Use

The insertion of the battery (532.003) in the battery casing (532.002), the insertion/removal of the battery casing in/from the handpiece (532.101) as well as the respective precautions and warnings are described in the chapter Use, pages 9–13.

The following additional information should be considered:

- In order to open the lid of the battery casing (532.002), it is only necessary to turn the lid sideways and to pull to open.
- In order to charge the battery (532.003), the Synthes Universal Battery Charger (530.600, 530.601) or the Synthes Universal Battery Charger II (05.001.204) can be used.
- Before first use or after storing the battery (532.003) outside of the charger for more than one month, a refreshing-cycle with the Synthes Universal Battery Charger II (05.001.204) may be necessary for the battery to be fully charged. In case the batteries are charged with the Universal Battery Charger (530.600, 530.601), please be aware that the batteries might not be fully charged during the five first uses.

Care and Maintenance

All information related to Care and Maintenance is contained in the corresponding section, pages 30–47.

Technical data

Battery for Nos. 532.001 and 532.010, 12V, standard (532.003)

Operating Voltage:	12 VDC
Battery capacity:	0.5 Ah
Battery type:	NiCd (Nickel Cadmium)
Empty battery charging time:	max. 60 min.

Ordering Information

Drive unit		511.773	Torque Limiter, 1.5 Nm, for AO/ASIF Quick Coupling
532.101	Colibri II	511.776	Torque Limiter, 0.8 Nm, with AO/ASIF Quick Coupling
Charger, Battery and Accessories for Battery		511.777	Torque Limiter, 0.4 Nm, with AO/ASIF Quick Coupling
532.132	Battery Casing for Nos. 532.101 and 532.110, with Locking for Lid	Accessories	
532.103	Battery for Nos. 532.101 and 532.110	68.001.255	Vario Case, size 1/1, for Colibri II and Small Battery Drive II, without Lid, without Contents
532.104	Sterile Cover for Nos. 532.101 and 532.110	689.507	Lid (Stainless Steel), size 1/1, for Vario Case
532.002	Battery Casing for Nos. 532.001 and 532.010, standard	68.001.253	Vario Case, size 1/2, for attachments for Colibri (II), Small Battery Drive (II) and Small Electric Drive
532.003	Battery for Nos. 532.001 and 532.010, 12V, standard	689.537	Lid (Stainless Steel), size 1/2, for Vario Case
532.004	Sterile Cover for Nos. 532.001 and 532.010	519.400	Cleaning Brush for Compact Air Drive, Power Drive, Colibri (II) and Small Electric Drive
05.001.204	Universal Battery Charger II	68.001.610	Washing Basket, size 1/1, for Colibri (II) and Small Battery Drive (II)
Attachments		68.001.602	Lid for Washing Basket, size 1/1
532.011	Mini Quick Coupling, for Nos. 532.001, 532.010, 532.101, 532.110 and 05.001.175	68.000.100	Support for washing-machine baskets
532.012	J-Latch Coupling, for Nos. 532.001, 532.010, 532.101, 532.110 and 05.001.175	519.970	Synthes Special Oil, 40 ml
05.001.250	AO/ASIF Quick Coupling, for Nos. 532.001, 532.010, 532.101, 532.110 and 05.001.175	532.024	Cleaning Brush for Oscillating Saw Attachment II (532.023)
05.001.251	Screw Attachment with AO/ASIF Quick Coupling, for Nos. 532.001, 532.010, 532.101, 532.110 and 05.001.175	310.932	Spare Key for Drill Chuck, clamping range up to \varnothing 4.0 mm
05.001.252	Chuck (Drilling Speed), with Key, clamping range up to \varnothing 4.0 mm	510.191	Spare Key for Drill Chuck, clamping range up to \varnothing 7.3 mm
05.001.253	Chuck (Drilling Speed), with Key, clamping range up to \varnothing 7.3 mm	Cutting Tools	
05.001.254	Chuck (Reaming Speed), with Key, clamping range up to \varnothing 7.3 mm, with reverse motion	Detailed ordering information on the cuttings tools for the Colibri II system with original size pictures can be found in the brochure "Small Bone Cutting Tools" (DSEM/PWT/1014/0044).	
532.015	Quick Coupling for DHS/DCS triple reamers, for Nos. 532.001, 532.010, 532.101, 532.110 and 05.001.175		
532.017	AO/ASIF Quick Coupling for Medullary Reaming, for Nos. 532.001, 532.010, 532.101, 532.110 and 05.001.175		
532.018	Hudson Quick Coupling for Medullary Reaming, for Nos. 532.001, 532.010, 532.101, 532.110 and 05.001.175		
532.019	Trinkle Quick Coupling, for Nos. 532.001, 532.010, 532.101, 532.110 and 05.001.175		
532.020	Trinkle Quick Coupling, modified, for Nos. 532.001, 532.010, 532.101, 532.110 and 05.001.175		
532.022	Quick Coupling for Kirschner Wires \varnothing 0.6 to 3.2 mm, for Nos. 532.001, 532.010, 532.101 and 532.110		
05.001.187	Burr Attachment, for Nos. 532.001, 532.010, 532.101, 532.110 and 05.001.175		
532.021	Oscillating Saw Attachment, for Nos. 532.001, 532.010, 532.101, 532.110 and 05.001.175		
532.023	Oscillating Saw Attachment II (Crescentic Technique), for Nos. 532.001, 532.010, 532.101, 532.110 and 05.001.175		
532.026	Large Oscillating Saw Attachment, for Nos. 532.001, 532.010, 532.101, 532.110 and 05.001.175		
532.031	Adapter for Radiolucent Drive, for Nos. 532.001, 532.010, 532.101, 532.110 and 05.001.175		
511.300	Radiolucent Drive		

